

**Stainless Steel Sinks**

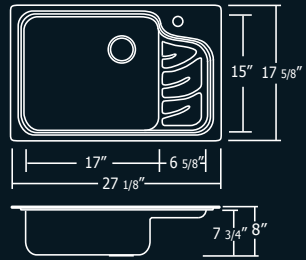

*PC-D061*



27 1/8" x 17 5/8" x 7 3/4"  
 Minimum Cabinet Size: 30"  
 Single Bowl w/ Drain Board,  
 19 Gauge



*PC-D981*

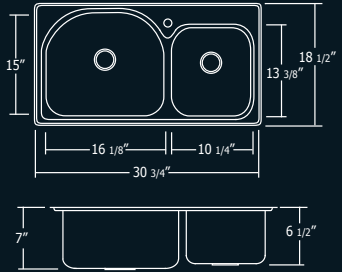

30 3/4" x 18 1/2" x 7"  
 Minimum Cabinet Size: 33"  
 Large & Small Bowl, 22  
 Gauge



*PC-D341 / 343*

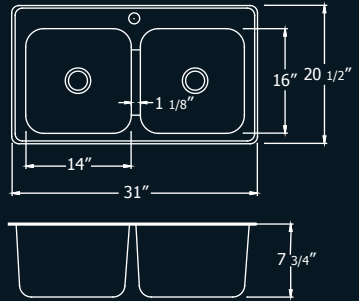

31" x 20 1/2" x 7 3/4"  
 Minimum Cabinet Size: 33"  
 Double Bowl (Model#: 341  
 - Single Faucet Hole, 343 - 8"  
 Centre Set Faucet Holes), 19  
 Gauge



*PC-D701*

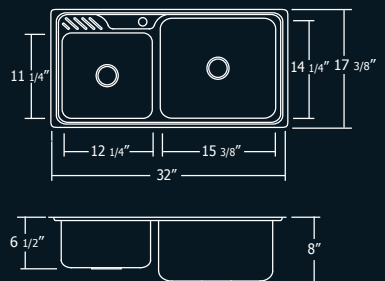

32" x 17 3/8" x 8"  
 Minimum Cabinet Size: 33"  
 Large & Small Bowl, 22 Gauge

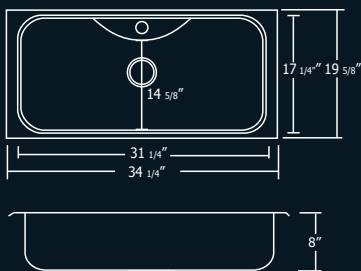

*PC-D331*

34 1/4" x 19 5/8" x 8"  
 Minimum Cabinet Size: 36"  
 Single Bowl w/ Accessories,  
 19 Gauge

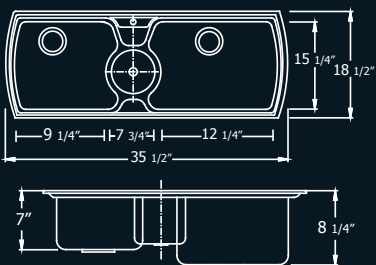

*PC-D321*

35 1/2" x 18 1/2" x 8 1/4"  
 Minimum Cabinet Size: 36"  
 Double Bowl with Built In  
 Strainer, 19 Gauge

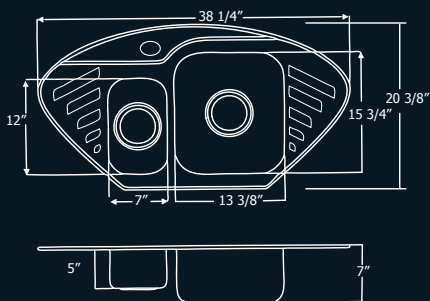

*PC-D311*

38 1/4" x 20 3/8" x 7"  
 Minimum Cabinet Size: 36"  
 Large & Small Bowls  
 w/ drain board, 19 Gauge

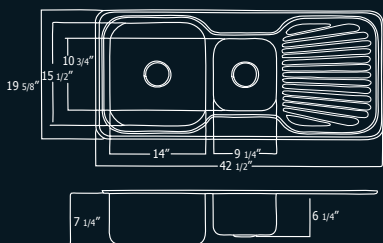

*PC-D040*

42 1/4" x 19 5/8" x 7 1/4"  
 Minimum Cabinet Size: 44"  
 Large & Small Bowl with  
 Drain Board, 20 Gauge



*PC-U270*

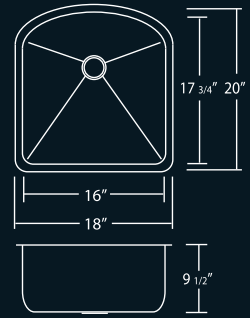

18" x 20" x 9 1/2"  
Minimum Cabinet Size: 21"  
Single Bowl, 16 Gauge



*PC-U030*

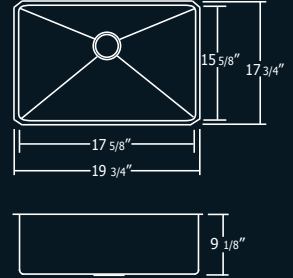

19 3/4" x 17 3/4" x 9 1/8"  
Minimum Cabinet Size: 24"  
Single Bowl, 16 Gauge



*PC-U260*

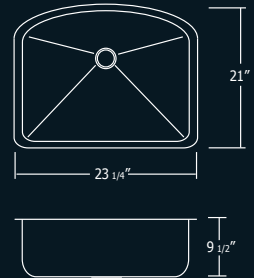

23 1/4" x 21" x 9 1/2"  
Minimum Cabinet Size: 27"  
Single Bowl, 16 Gauge

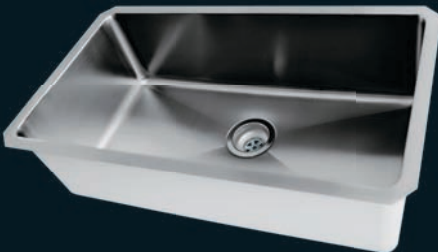

*PC-U050*

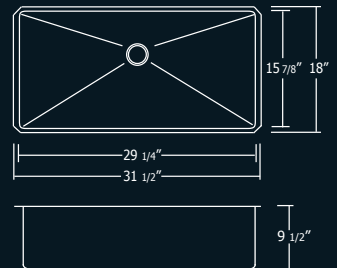

31 1/2" x 18" x 9 1/2"  
Minimum Cabinet Size: 33"  
Single Bowl, 16 Gauge

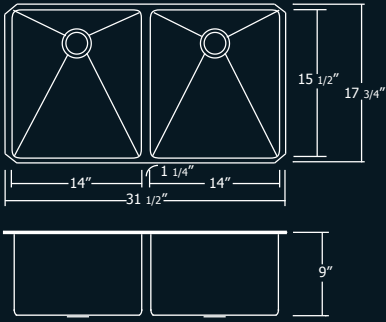

**31 1/2" x 17 3/4" x 9"**  
**Minimum Cabinet Size:**  
**33" Double Bowl, 16 Gauge**

*PC-U100*

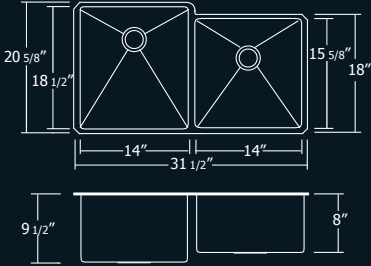

**31 1/2" x 20 5/8" x 9 1/2"**  
**Minimum Cabinet Size: 33"**  
**Large & Small Bowl, 16 Gauge**

*PC-U250*

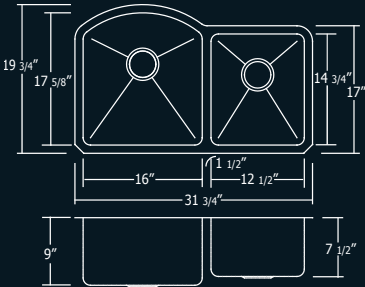

**31 3/4" x 19 3/4" x 9"**  
**Minimum Cabinet Size: 33"**  
**Large & Small Bowl, 16 Gauge**

*PC-U200*

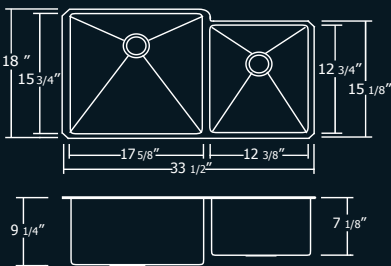

**33 1/2" x 18" x 9 1/4"**  
**Minimum Cabinet Size: 36"**  
**Large & Small Bowl, 16 Gauge**

*PC-U110*



*PC-U240*

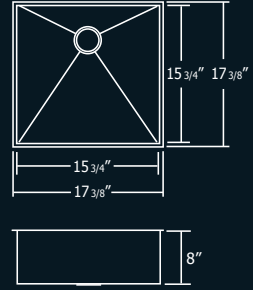

17 3/8" x 17 3/8" x 8"  
Minimum Cabinet Size: 18"  
Single Bowl, 18 Gauge



*PC-U190*

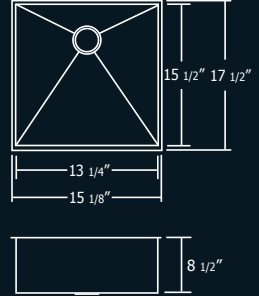

15 1/8" x 17 1/2" x 8 1/2"  
Minimum Cabinet Size: 18"  
Single Bowl, 18 Gauge



*PC-U120*

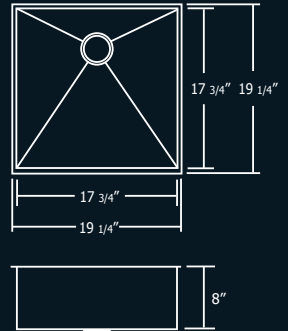

19 1/4" x 19 1/4" x 8"  
Minimum Cabinet Size: 21"  
Single Bowl, 18 Gauge



*PC-U140*

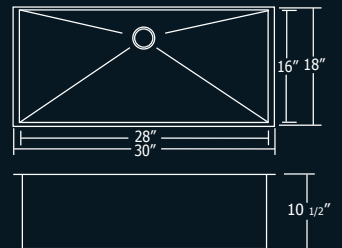

30" x 18" x 10 1/2"  
Minimum Cabinet Size: 33"  
Single Bowl, 16 Gauge

**UNDERMOUNT 90 DEGREE CORNERS**

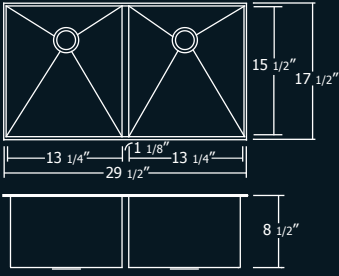

29 1/2" x 17 1/2" x 8 1/2"  
Minimum Cabinet Size: 33"  
Double Bowl, 18 Gauge

*PC-U090*

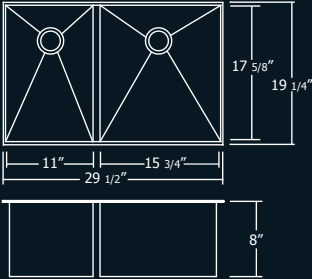

29 1/2" x 19 1/4" x 8"  
Minimum Cabinet Size: 33"  
Large & Small Bowl, 18 Gauge

*PC-U220*

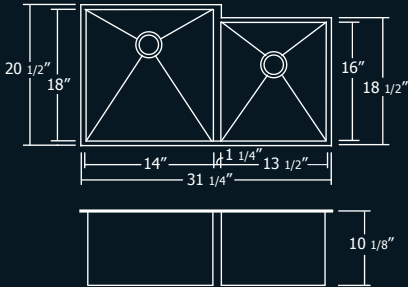

31 1/4" x 20 1/2" x 10 1/8"  
Minimum Cabinet Size: 33"  
Large & Small Bowl, 18 Gauge

*PC-U230*

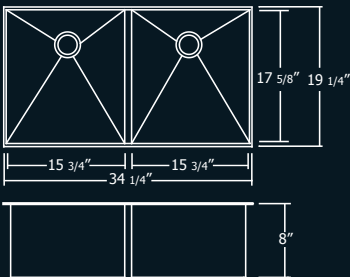

34 1/4" x 19 1/4" x 8"  
Minimum Cabinet Size: 36"  
Double Bowl, 18 Gauge

*PC-U210*



*PC-U020*

12 7/8" x 13 3/4" x 7"  
Minimum Cabinet Size: 15"  
Single Bowl, 18 Gauge

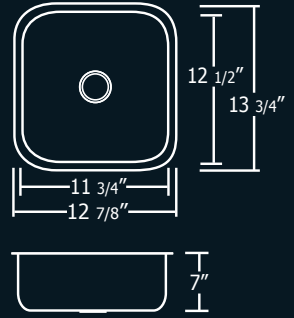

*PC-U040*

22 1/4" x 18 1/4" x 9"  
Minimum Cabinet Size: 24"  
Single Bowl, 18 Gauge

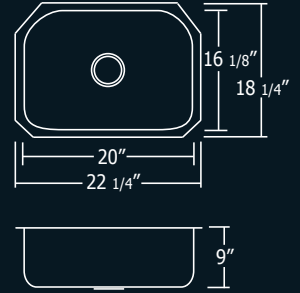

*PC-U180*

23 1/4" x 17 3/4" x 9"  
Minimum Cabinet Size: 24"  
Single Bowl, 18 Gauge

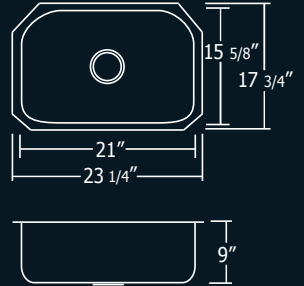

*PC-U331*

34" x 19 1/4" x 8 3/8"  
Minimum Cabinet Size:  
36" Single Bowl  
w/ accessories, 19 Gauge

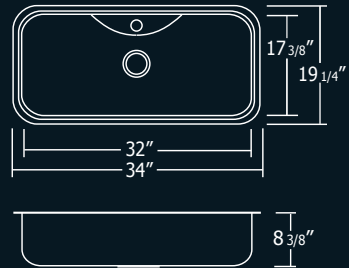

*PC-U891*

29 5/8" x 16" x 8 1/4"  
Minimum Cabinet Size: 33"  
Large & Small Bowl, 19 Gauge

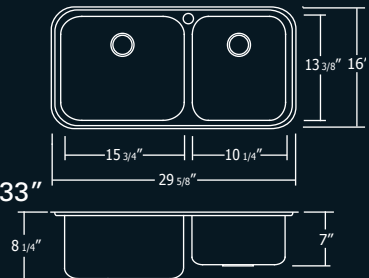

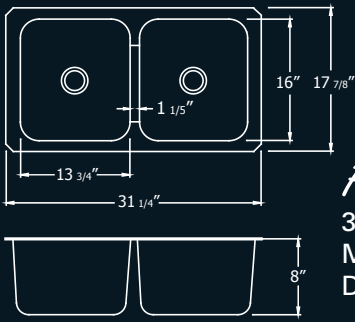

**PC-U320**

31 1/4" x 17 7/8" x 8"  
 Minimum Cabinet Size: 33"  
 Double Bowl, 20 Gauge

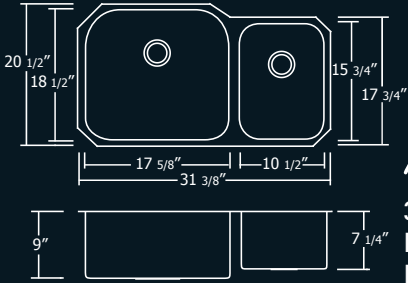

**PC-U080**

31 3/8" x 20 1/2" x 9"  
 Minimum Cabinet Size: 33"  
 Large & Small Bowl, 18 Gauge



**UNDERMOUNT WITH INTEGRAL APRON**

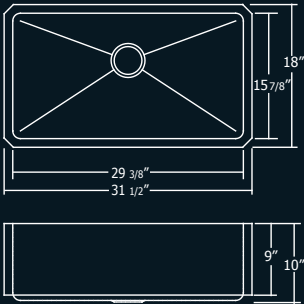

**PC-K011**

31 1/2" x 18" x 10"  
 Minimum Cabinet Size: 33"  
 Single Bowl w/ Small Radius  
 Corners, 16 Gauge

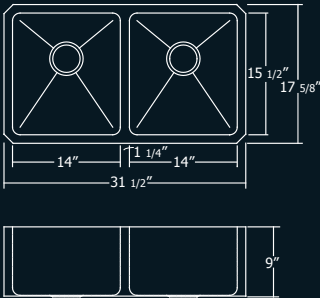

**PC-K021**

31 1/2" x 17 5/8" x 9"  
 Minimum Cabinet Size: 33"  
 Double Bowl w/ Small  
 Radius Corners, 16 Gauge

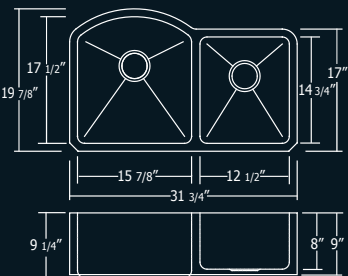

**PC-K031**

31 3/4" x 19 7/8" x 9 1/4"  
 Minimum Cabinet Size: 33"  
 Large & Small Bowl w/ Small  
 Radius Corners, 16 Gauge



**UNDERMOUNT & UNDERMOUNT WITH INTEGRAL APRON**



*PC-D020*

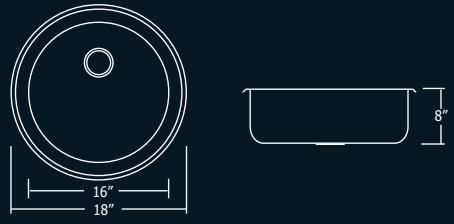

**18" x 18" x 8"**  
Minimum Cabinet Size: 21"  
Round Bar Sink, 20 Gauge



*PC-D071*

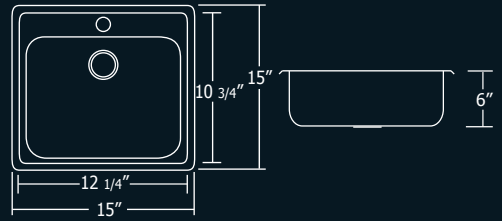

**15" x 15" x 6"**  
Minimum Cabinet Size: 18"  
Square Bar Sink, 24 Gauge



*PC-D053*

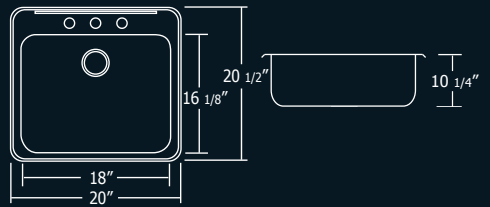

**20" x 20 1/2" x 10 1/4"**  
Minimum Cabinet Size: 21"  
Deep Laundry Sink, 19 Gauge



*PC-D031*

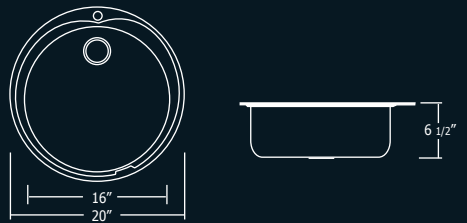

**20" x 20" x 6 1/2"**  
Minimum Cabinet Size: 21"  
Round Bar Sink, 22 Gauge

Distinguished by the enchanting curvy lines, all sink faucets exude an approachable, simple elegance.



*86001*

Single Lever Sink Mixer



*86003*

Single Lever Sink Mixer With  
Swivel Spout and Pullout Sprayhead



*86002*

Single Lever Sink Mixer

## HOW TO SELECT THE CORRECT CABINET SIZE?

### SINK CABINET SIZING

Measure your cabinet's outside width (side to side). Make sure you select a sink with a minimum recommended cabinet size no larger than this measurement.

Measure your countertop from back to front. If you have a post formed backsplash, do not forget to subtract this from your measurement. Remember that if you have an Undermount sink, or a sink without a lip for faucets, you will need to allow space for faucets in choosing your sink.

### INSTALLATION PROFILES FOR UNDERMOUNT SINKS

There are three methods of installing your Undermount sink, which will reveal varying amounts of the top profile of the sink. Acri-tec sinks can be installed with either an overhanging profile, a flush profile, or a set-back profile.

Ask your countertop fabricator to adjust the cut-out opening to suit whichever installation you require.

Remember in choosing your Undermount sink to consider the depth of the countertop. If the countertop has a thickness of 1", after final installation your Undermount sink will have an extra 1" added to its total depth.



## **ACRI-TEC**

Acri-tec Industries Corp.  
27049 Gloucester Way  
Langley, BC V4W 3V6  
Phone: (604) 607-0856  
Fax: (604) 607-0857

[www.acritec.com](http://www.acritec.com)

Toll Free: 1-877-464-3100  
E-mail: [sales@acritec.com](mailto:sales@acritec.com)

© 2011 by Acri-tec Industries Corp.