

Shower Base 60" x 38"

Barrier Free

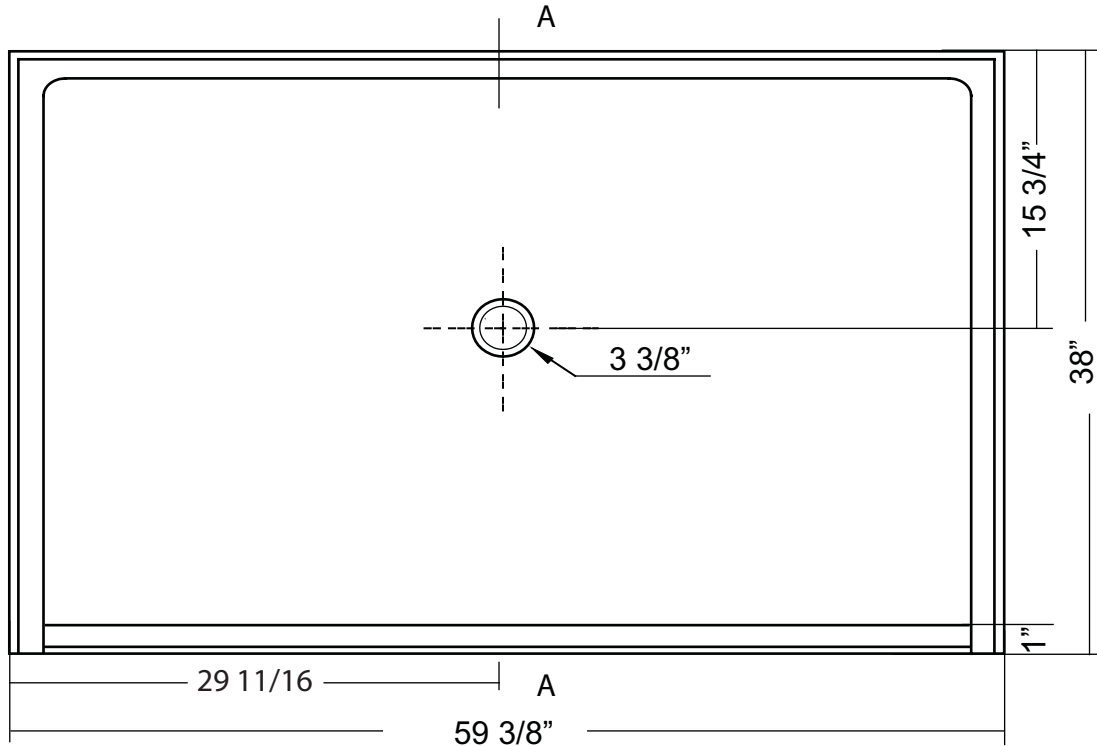

A-A Cut View

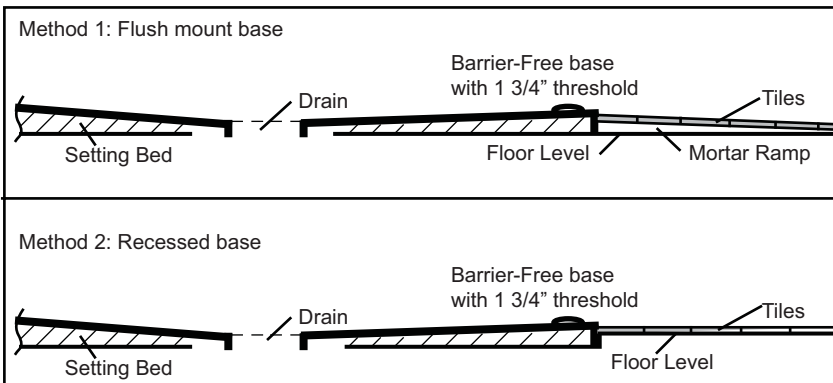
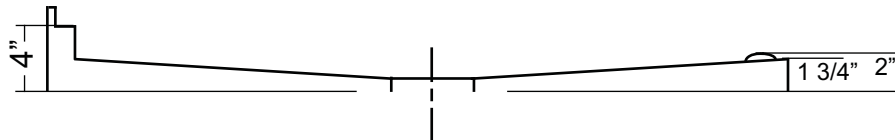

Diagram not to scale.

All Measurements: ± 1/4"

Drain Hole: 3 3/8"

Shower base trimmed to fit 60" x 38" rough opening.

Barrier Free shower bases are designed to accommodate a collapsible threshold. These are available as an accessory from Acri-tec.



This shower base complies with CSA Standards

In keeping with our policy of continuing product improvement, Acri-Tec Industries Corp., reserves the right to change product specifications without notice.