

Shower Base 48" x 42"

Barrier Free

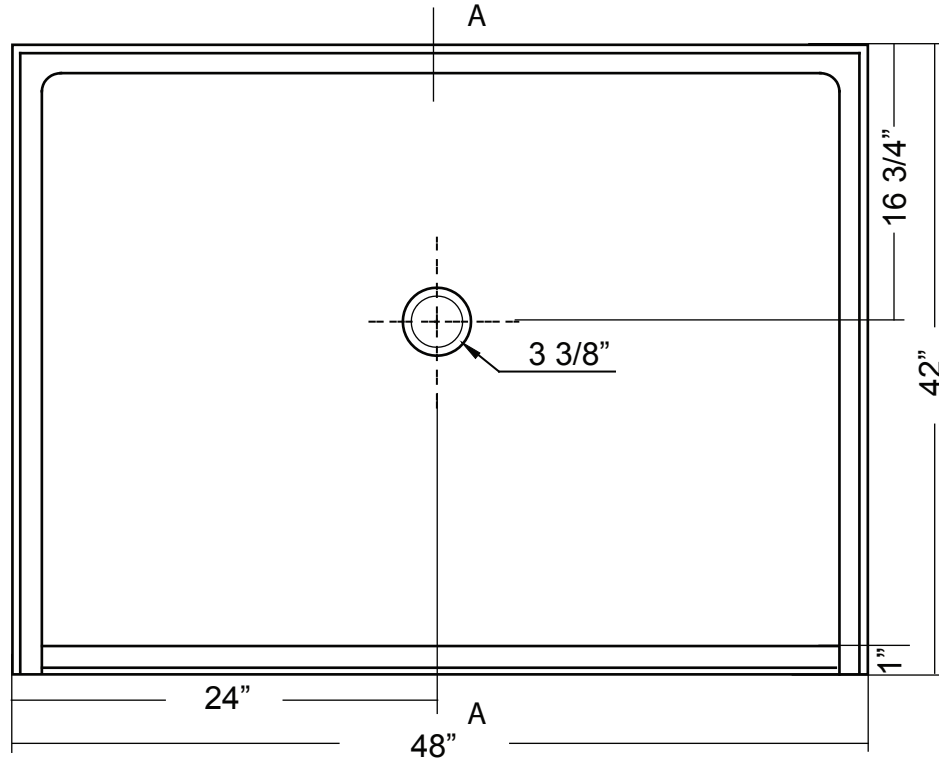

A-A Cut View

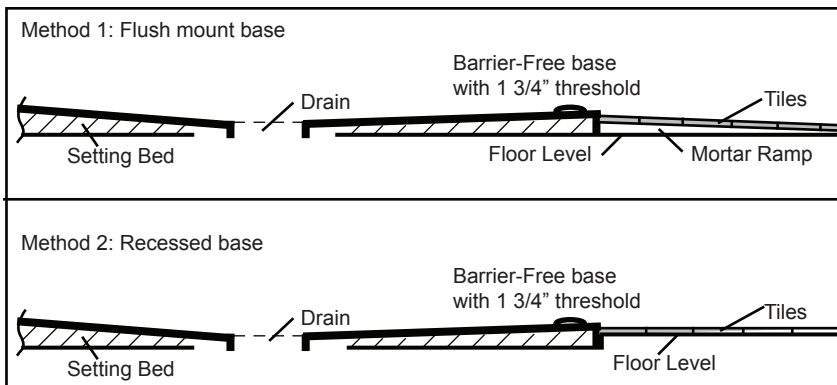

Diagram not to scale.

All Measurements: $\pm 1/4"$

Drain Hole: $3 3/8"$

Shower base trimmed to fit 48" x 42" rough opening.

Barrier Free shower bases are designed to accommodate a collapsible threshold.
These are available as an accessory from Acri-tec.



This shower base complies with CSA Standards

In keeping with our policy of continuing product improvement, Acri-Tec Industries Corp., reserves the right to change product specifications without notice.