

MODEL

38" x 38" Saniflo



*1 year limited manufacturer's warranty included

*Note: Shower base may not be exactly as pictured

DESIGN FEATURES

- Acrylic shower base constructed of cast high gloss acrylic and reinforced with a fibreglass backing
- Standard 3 3/8" shower drain opening
- Shower base trimmed to fit 38" x 38" rough opening
- Integral tiling flange for easy installation
- Floor of the base is elevated to allow room to install the shower drain plumbing

OPTIONS

- Available in;
 - White

SHOWER BASE DIMENSIONS

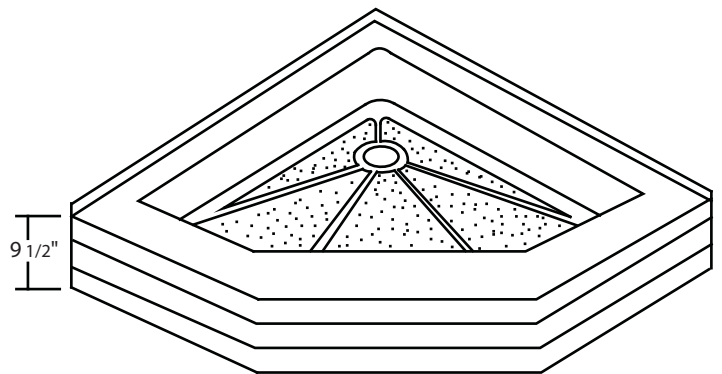
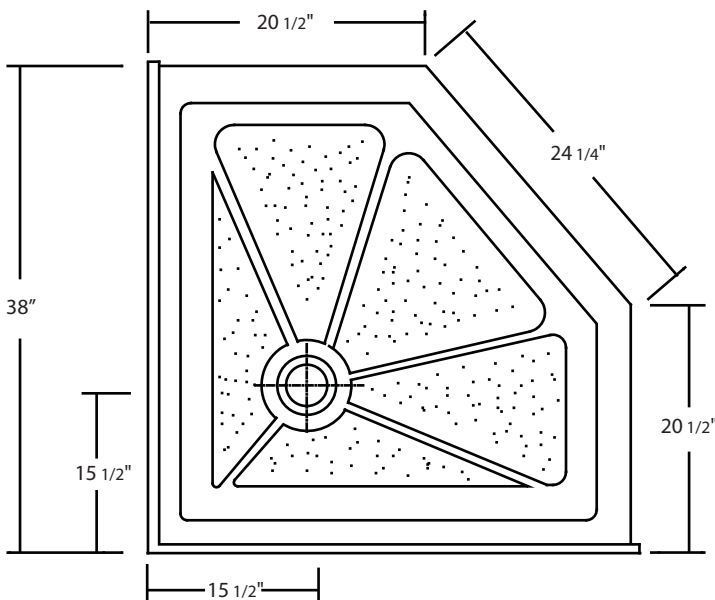

*Diagram is not to scale



This shower base complies with CSA Standards

*Shower Drains are not included
All measurements $\pm 1/4"$

In keeping with our policy of continuing product improvement, Acric-Tec Industries Corp., reserves the right to change product specifications without notice.