

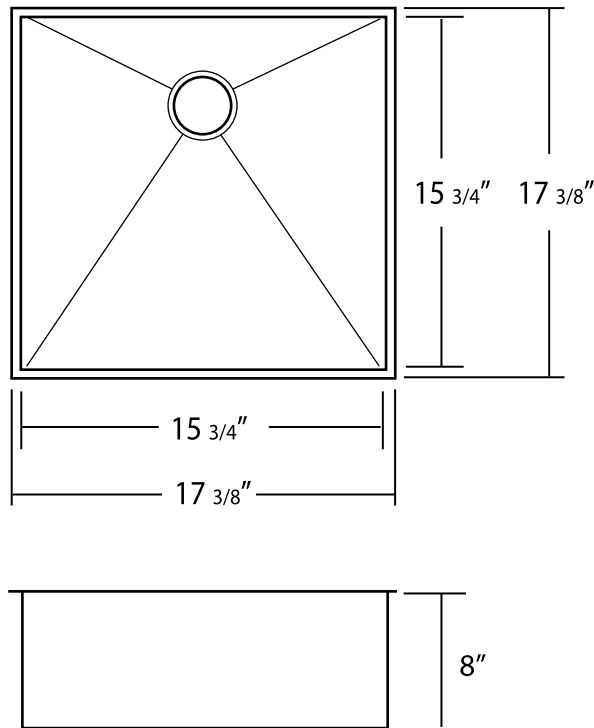

**Acri-Tec Industries Corp.**  
32829 London Avenue, Mission, BC V2V 6M7  
Tel: (604) 826-3100 Fax: (604) 826-3149  
sales@acritec.com

**PC-U240 17 3/8" x 17 3/8" x 8"**  
Platinum Collection Kitchen Sink



All Measurements:  $\pm 1/4"$