



48" x 48"

Product # 72041

Barrier Free | Single Threshold

Product Specifications

- 100% Acrylic with fiberglass and wood reinforcement
- Pre-levelled
- Standard 3 3/8" shower drain opening
- 1 Year limited manufacturer's warranty included

Design Features

- Acrylic shower base constructed of cast high gloss acrylic and reinforced with a fibreglass backing
- Shower base trimmed to fit 48" x 48" rough opening
- Designed to accommodate a collapsible threshold.
- integral tiling flange for easy installation

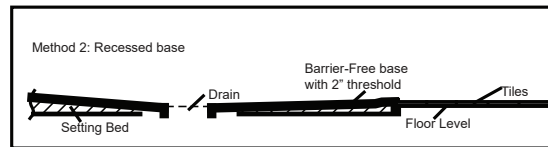
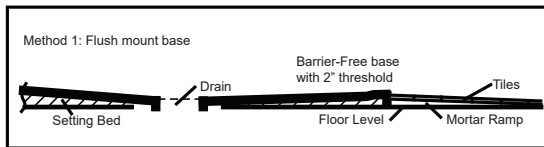
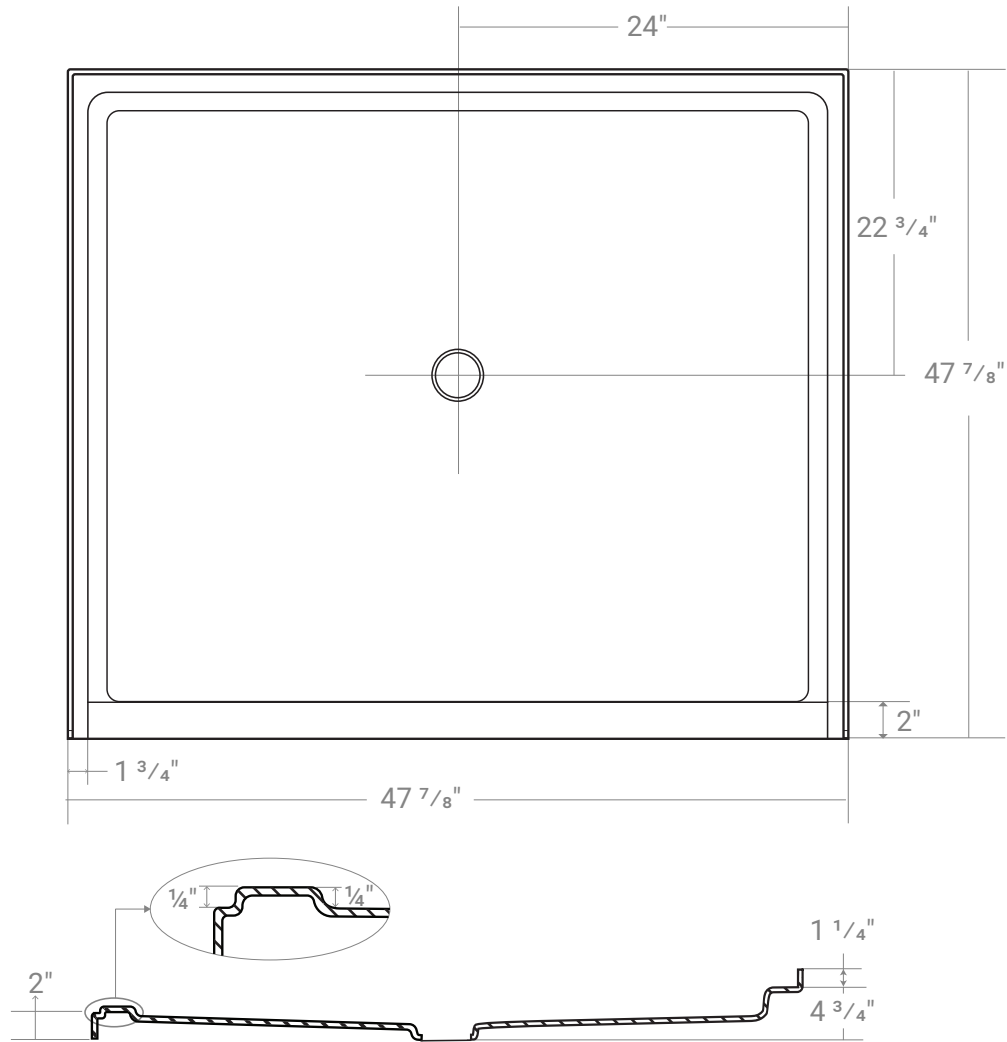

Acritec Industries Corp.

27049 Gloucester Way
Langley, B.C. V4W 3Y3

Tel: 604.607.0856

Fax: 604.607.0857

Email: info@acritec.com

Website: www.acritec.com

In keeping with our policy of continuing product improvement, Acritec Industries Corp. reserves the right to change product specifications without notice.

Important

*While we strive to provide accurate measurements for our customers, sometimes mistakes happen. Our goal is to help things run smoothly from shipment to installation, so if you notice any errors in our spec sheets, please let us know.

Our products are handmade & hand finished so you can expect a tolerance of $\pm 1/4$ " on all measurements. The water pooling on the Acritec acrylic shower bases of 4 inches is a normal tolerance. This is natural because of the surface tension of the water on plastic surfaces. We strongly recommend waiting until your ordered product is on-site before attempting any rough-in carpentry or plumbing.

If you want to verify any of our measurements, please feel free to call or email us.

*Drawings are not to scale